



Users' Manual

SWITCHER

Model: HDS9106

VER 1.0



SDI

HDMI

Precautions

About this device:

- This device belongs to the high-frequency video processing equipment. Therefore, please strictly observe the following points:
- Non-professionals are not allowed to disassemble the equipment case without permission. Do not repair it yourself to avoid accidents or damage to the equipment.
- Do not spill any chemicals or liquids on or near the equipment.
- The power supply of the device will generate heat during operation. Therefore, keep the working environment well ventilated to avoid damage to the device due to excessive temperature.
- Do not place system equipment in a location that is too cold or too hot.
- Operate the equipment in an environment where the temperature is between 0-70 degrees Celsius (32-158 degrees Fahrenheit) and the humidity is between 10% and 80%.
- Try to keep the product environment clean and avoid dust, otherwise there is a danger of destroying the product.
- When using the product, keep it away from electromagnetic fields.



- Do not dispose of this product as normal waste. This product is designed to be recyclable.

Copyright:

When using this unit for video and/or audio switching, publishing over the Internet, or the like, in some cases it may be necessary to authorize the copyright owner of the video or audio. In order to protect copyright, please strictly observe the following points when using this device:

- When connecting a recording device to this unit and recording video or audio, be sure to follow the relevant copyright laws.
- It is prohibited by law to display or publish third-party copyrighted video and audio materials, or to allow private or public access without the permission of the copyright holder.
- Even if you have the right to display or publish, for example, editing activities that use this unit to erase or disassemble the original content may still be prohibited by law. For the purpose of copyright protection, the specifications of the video and audio signals that can be input may change without notice due to software upgrades or feature extensions.
- According to copyright laws, recorded video and audio may not be used for purposes other than personal preferences without the permission of the copyright holder. Please note that even if it is based on personal preference,
- It may also limit shooting during live performances, performances or exhibitions.

Contents

Precautions	2
1. Overview	4
1.1 Introduction	4
2. Functional characteristics	5
3. Preparation Before Installation	6
4. Equipment Unpacking	7
4.1 Size: 255*160*60mm	7
5. Interface Specification	8
5.1 Interface Introduction	8
5.2 TALLY Interface	9
5.3 Parameters	10
6. Control Panel and Interface	11
6.1 Control Panel	11
6.1.1 Area Description	11
6.1.2 Key Description	12
6.1.2.1 Audio Control Area	12
6.1.2.2 Transition Effect Control Area	16
6.1.2.3 Integrated Control Area	18
6.1.2.4 PGM & PVW Selection	21
7. System menu settings	24
8. Failure and Maintenance	25
8.1 Common Faults and Solutions	25
8.2 Maintenance	25
8.2.1 Warranty information	26

1. Overview

1.1 Introduction

DeviceWell HD Video Switcher HDS9106 adopts portable integrated design, Clamshell metal casing, standard size: 390*290*100mm, which can be used for video special effects switching in small outdoor scenes. The device integrates common components such as multiview processor, special effects generator, audio processor, and control keyboard.

The HDS9106 supports 4 channels of broadcast SDI and 2 channels of HDMI for a total of six video signals. The external preview signal can be output synchronously. The HDS9106 supports SDI embedded audio + external analog audio. After mixing, it can be embedded in the output SDI signal or output from the analog port. The resolution of all input signals is automatically adapted, and the output signal resolution can be selected as required, which is quite flexible. For the video switching needs of broadcast TV, outdoor sports events, school courseware production, etc., the functions of HDS9106 can be fully satisfied.

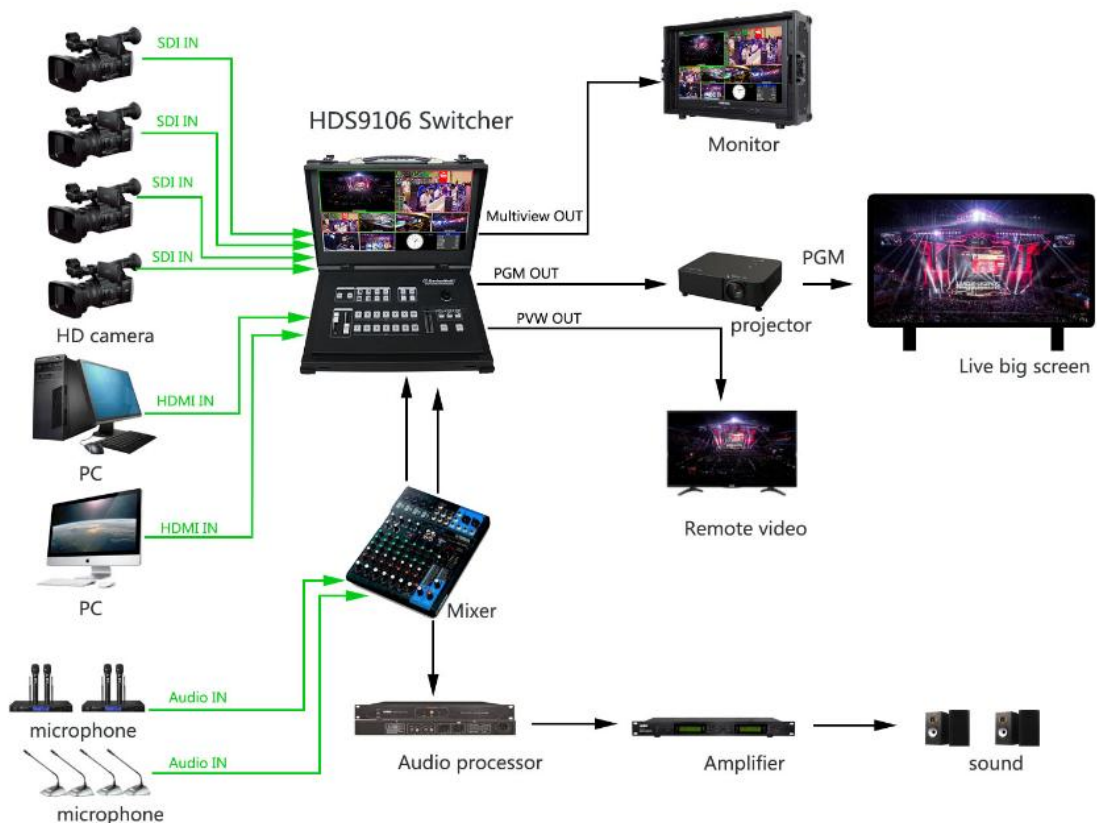

2. Functional characteristics

The DeviceWell HDS9106 6-channel HD video switcher is a multi-function switcher that requires no special knowledge and can be used for video switching and audio mixing with simple operation. This unit can be used in radio and television, live broadcast and various activities.



- ◆ Portable integrated design
- ◆ Advanced black metal body, high strength and light weight
- ◆ Integrated control keyboard
- ◆ Supports up to 4 SDI and 2 HDMI inputs
- ◆ 3.5mm analog audio input and output
- ◆ 1-channel lotus seat audio input and output
- ◆ Support PIP/POPs screen windowing function
- ◆ Audio support follow and mix assignment mode
- ◆ Support 1 channel SDI output custom PGM/PVW
- ◆ PGM output: 2-CH SDI and 1-channel HDMI
- ◆ Multiview output: 1 CH HDMI and 1 CH SDI
- ◆ Support special effects switching such as MIX / FADE
- ◆ Support CUT hard support for AUTO effect switching, Transition rate adjustable
- ◆ Support Tally / network remote control
- ◆ Built-in chassis temperature detection and fan intelligent control system
- ◆ Support software online upgrade

3. Preparation Before Installation



Caution

- During transportation, handling, and installation of switchboard equipment, avoid collisions between the switchgear equipment and doors, walls, shelves, etc.
- When the equipment is unpacked and transported, it is strictly forbidden to put it down and drag it gently to avoid damage to the switchboard equipment.
- Do not place the switcher equipment in a flammable, explosive atmosphere or smoke environment. Do not perform any operation in this environment.
- Operating equipment should be kept away from water and moisture. The water in the switchgear or moisture will cause damage to the circuit of the switchgear equipment.
- A certain amount of heat will be generated during the operation of the switcher. Ensure that the switchgear equipment is ventilated and the switcher device can operate normally.



Danger

- It is a fatal hazard that indirect contact with the power supply by wet objects is prohibited. Unregulated, incorrect high-voltage operation can cause accidents such as fire or electric shock.
- It is forbidden to install and remove the switchgear equipment and power cord. When the power cord is in contact with the conductor, an arc or spark may be generated, which may result in fire or electric shock.

4. Equipment Unpacking



When unpacking inspection, if the sealing label or packaging is found to be damaged, stop unpacking and report the situation to the equipment dealer. If the quantity of the goods is correct and the packaging is intact, the goods can be inspected.

4.1 Size: 390*290*100 mm

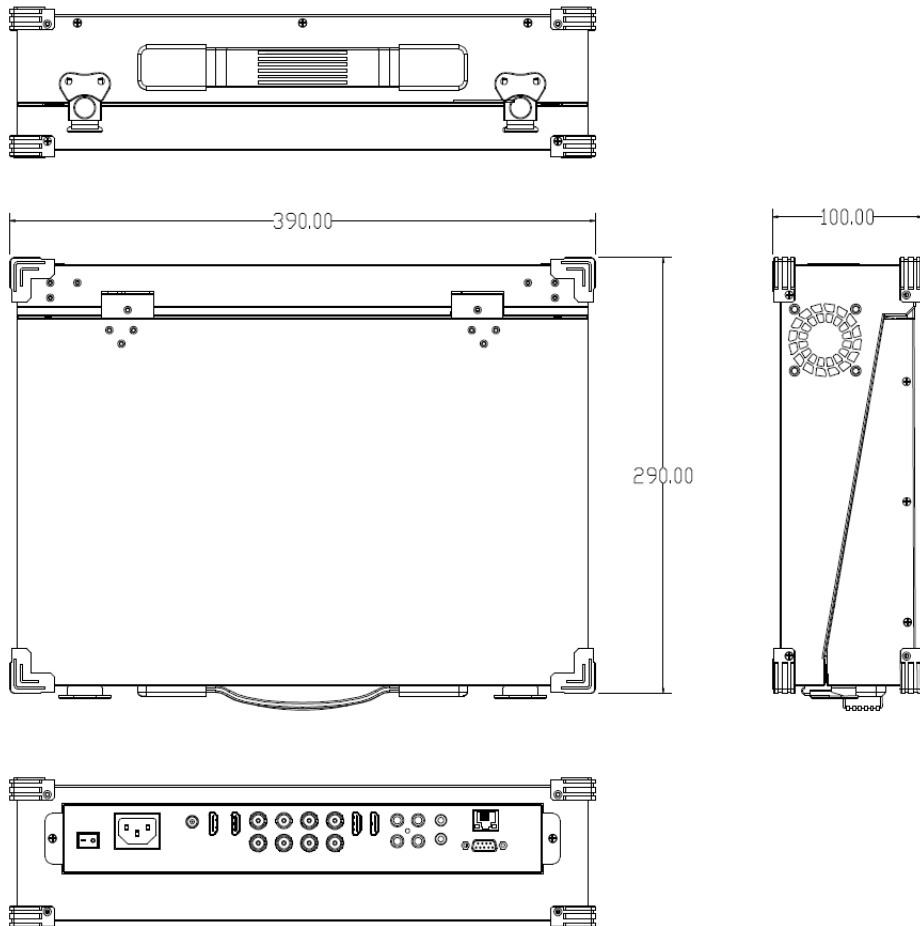

5. Interface Specification

5.1 Interface Introduction

The DeviceWell HDS9106 interface is shown below.



NO.	Definition	Description
1	TALLY/RS232(reserved)	TALLY / serial port control (reserved)
2	LAN	Network upgrade
3	AUDIO IN/OUT	3.5mm audio input and output
4	AUDIO OUT	RCA audio output
5	AUDIO IN	RCA audio input
6	HDMI OUT	PGM live output
7	MULTIVIEW OUT	HDMI and SDI multiview output
8	AUX	Auxiliary output, custom PGM/PVW
9	SDI OUT	PGM live output
10	SDI IN	4-channel SDI video source input
11	HDMI IN	2-channel HDMI video source input
12	DC 12V	Power input and power switch
13	AC 110-240V	Power input

5.2 TALLY Interface

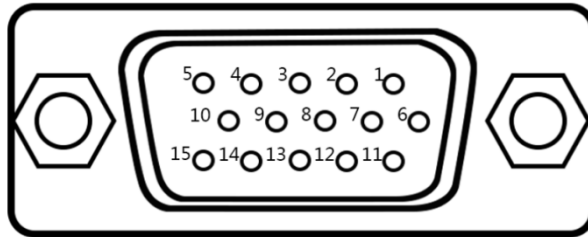

PIN	Function	PIN	Function
11	PGM-IN1	6	PVW-IN1
12	PGM-IN2	7	PVW-IN2
13	PGM-IN3	8	PVW-IN3
14	PGM-IN4	9	PVW-IN4
15	PGM-IN5	10	PVW-IN5
3	PGM-IN6	4	PVW-IN6
5	GND		

Note : PIN1 PIN2 not used.

TALLY : Online schematic

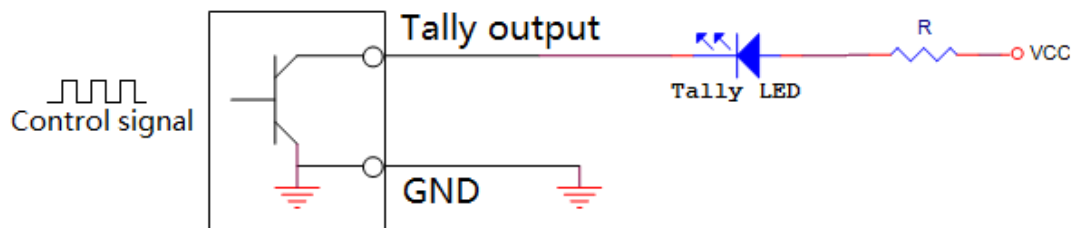

Note : Tally LED: for external display device

Tally output : Active low (Tally LED is lit) High level is invalid (Tally out is off)

5.3 Parameters

Product Name	Clamshell switcher	
Product Model	HDS9106	
Video Signal Input	Input signal	SDI/HDMI Video Signal
	Bit rate	270Mbps~3Gbps
	Connector	Standard
	Reflection loss	>15dB 5MHz~3GHz
	Signal amplitude	800mV ±10%(SDI/ HDMI)
	Impedance	100Ω (HDMI) 75Ω(SDI)
	Equilibrium	Adaptive
	Support DVD Input HDMI	480i/576i, 480p/576p, 720p, 1080i, 1080p
	Support Computer HDMI Input	1920x1080, 1680x1050, 1600x900, 1440x1050, 1366x768, 1360x768, 1360x768, 1280x1024, 1280x960, 1280x800, 1280x768, 1280x720, 1280x600, 1152x864, 1024x768, 800x600
Video Signal Output	Output signal	SDI/HDMI Video Signal
	Bit rate	270Mbps~3Gbps
	Connector	Standard
	Reflection loss	>15dB 5MHz~3GHz
	Signal amplitude	800mV ±10%(SDI/ HDMI)
	Impedance	100Ω (HDMI) 75 Ω(SDI)
	DC offset	0V ±0.5V
	Clock recovery	Support
Control Parameter	Serial control	RS232(Reserved)
	Control protocol	9600 baud, 8 bits, 1 stop position, invalid test
	Connection port	15-pin D-type port, 2-RX, 3-TX, 5-GND
	Network control	RJ45,100M
Common Parameters	Power supply	DC 12V/AC 110-240A
	Power	22W
	weight	5.16kg
	Control panel	Support on-site production, integration of many buttons.
	Operating	0°C~50°C No condensation
	Storage temperature	-20°C~75°C
	Working humidity	20%~70%RH
	Storage humidity	0%~90%RH , No condensation

6. Control Panel and Interface

Before using the HD Switcher HDS9106, please take a few minutes to read this section. This chapter will introduce you the panel and interface of the HD switcher to facilitate your subsequent use and operation.

The new high-strength characteristics of the new aluminum alloy with high-strength characteristics improve the anti-drop, anti-shock and shock-proof capabilities of the whole machine, and effectively protect the internal components of the equipment. Ultra-lightweight features make the unit easier to transport and maintain without the need for additional equipment; it also offers unparalleled thermal performance.

In addition to the innovation of the case, the HD switcher has also been completely optimized for the interface connector. Environmentally friendly materials with new RoHS standards are More demanding in terms of durability and environmental protection, to provide customers with more stable, more environmentally friendly, more cost-effective products.

6.1 Control Panel

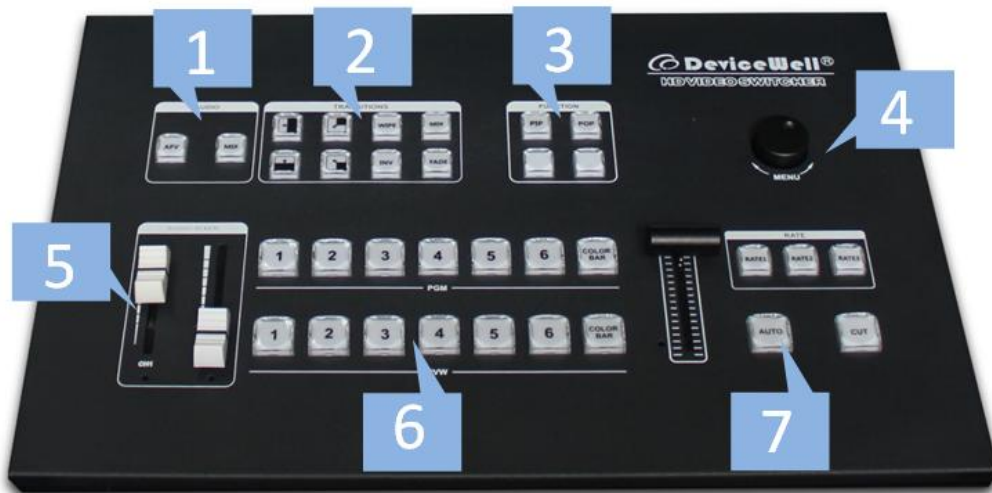

6.1.1 Area Description

NO.	Name	Description
1	Audio Control	Mainly for Audio Follow and mix settings.
2	Transition Effect Control	Select transition effects
3	Integrated control area	PIP and POP effects

NO.	Name	Description
4	Knob Control	Use the knob to set menu information
5	Audio fader	Main control output volume
6	PVW& PGM Select	Live broadcast and preview selection
7	T-Bar	Manual control of transitions

6.1.2 Key Description

6.1.2.1 Audio Control Area

- How to use the audio follow mode:

1. Press the AFV button on the operation panel. The button will light green at this time. The corresponding multi-screen menu will also display the current audio status. In the menu, Audio Mode displays Follow, indicating that the audio is in follow mode; as shown on the right.

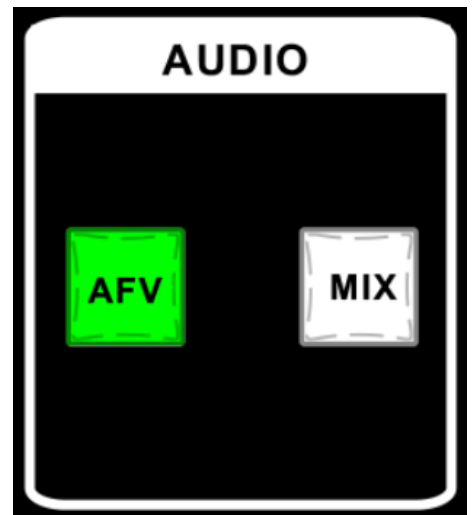

Under the audio follow mode, CH1, CH2, CH1_VOL and CH2_VOL in the menu will change to light gray, and the option is unusable, as shown in the image to the right.

STATUS	
CH1	IN6
CH2	RCA_IN
CH1_VOL	44
CH2_VOL	100
AUX	PGM
Audio Mode	Follow
PGM Out	1080P25

2. The channels of the audio follow mode are IN1-SDI1, IN2-SDI2, IN3-SDI3, IN4-SDI4, IN5-HDMI5, IN6-HDMI6, and the corresponding operation panel buttons (the button panel 2 lights up at this time, indicating that Operate the IN2-SDI2 signal source as shown below.



3. The volume adjustment of the audio follow mode is controlled by the mixer of the operation panel; pressing the AFV button of the following mode, the corresponding CH1 light will also be lit, and the audio fader is pushed up, the volume is higher. Big.

The position of the audio fader of CH1 is continuously adjusted up and down, and the corresponding menu portion can also display the current volume.

●How to use the mix assignment:

1. Press the MIX button on the operation panel, the button will light green at this time.

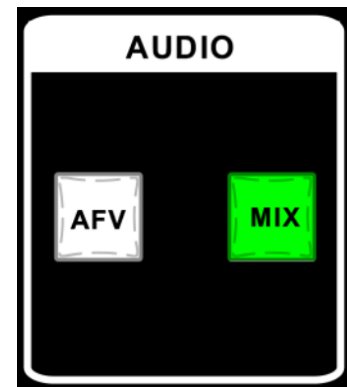
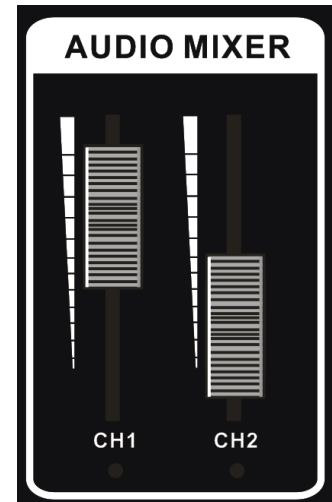

The menu corresponding to the multi-screen will also display the current audio status. In the menu, Audio Mode displays Mixing, indicating that the audio is in the mix assignment mode; (the CH1 and CH2 options are available in the menu) as shown on the right.

STATUS	
CH1	IN1
CH2	IN2
CH1_VOL	44
CH2_VOL	100
AUX	PGM
Audio Mode	Mixing
PGM Out	1080P25

2. The channels assigned by the mix are IN1-SDI1, IN2-SDI2, IN3-SDI3, IN4-SDI4, IN5-HDMI5, IN6-HDMI6, XLR_IN, RCA_IN. The mix assignment mode is followed by two additional audio add-on functions. XLR stands for 3.5mm audio interface, RCA stands for RCA audio interface; PGM live output can mix two channels of audio at the same time, the volume of two channels of audio can also be adjusted separately.



3.5mm Audio Interface



RCA Audio Interface

3. The audio channel adjustment of the mix assignment: through the control panel knob MENU to adjust, corresponding to the multi-screen menu to monitor the adjusted state

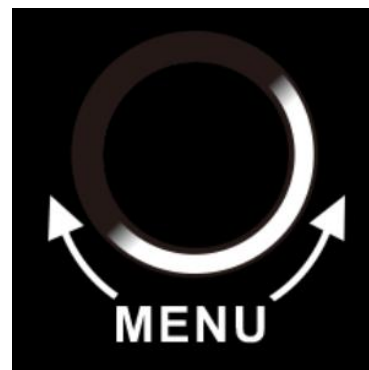

The knob rotates clockwise once, and the background color appears in the CH1 character in the menu, indicating that the first channel audio is currently adjusted; press the knob to enter the channel selection of the first channel audio IN1-SDI1, IN2-SDI2, IN3-SDI3, IN4-SDI4, IN5-HDMI5, IN6-HDMI6, Phone_IN (formerly device XLR_IN), RCA_IN, make sure to press the knob to exit;

STATUS	
CH1	IN1
CH2	IN2
CH1_VOL	44
CH2_VOL	100
AUX	PGM
Audio Mode	Mixing
PGM Out	1080P25
STATUS	
CH1	IN3
CH2	Phone_IN
CH1_VOL	44
CH2_VOL	100
AUX	PGM
Audio Mode	Mixing
PGM Out	1080P25

The CH2 audio channel is selected in the same way as the CH1. The knob rotates clockwise once, and the background color appears in the CH2 character in the menu. It indicates that the second channel audio is currently adjusted. Press the knob to enter the second channel and select IN1-SDI1, IN2-SDI2, IN3-SDI3, IN4-SDI4, IN5-HDMI5, IN6-HDMI6, Phone_IN (formerly device XLR_IN), RCA_IN, make sure to press the knob to exit.

STATUS	
CH1	IN3
CH2	Phone_IN
CH1_VOL	44
CH2_VOL	100
AUX	PGM
Audio Mode	Mixing
PGM Out	1080P25

STATUS	
CH1	IN3
CH2	Phone_IN
CH1_VOL	44
CH2_VOL	100
AUX	PGM
Audio Mode	Mixing
PGM Out	1080P25

4. The volume adjustment of the audio mixing mode is also controlled by the mixer of the operation panel; pressing the MIX button of the mixing mode, the corresponding CH1 and CH2 lights will be illuminated. CH1 corresponds to the volume adjustment of the first mix, and CH2 corresponds to the volume adjustment of the second mix. The more the audio fader is pushed up, the louder the volume.

Constantly adjust the position of the audio faders of CH1 and CH2 up and down, and the corresponding menu section can also display the current volume.

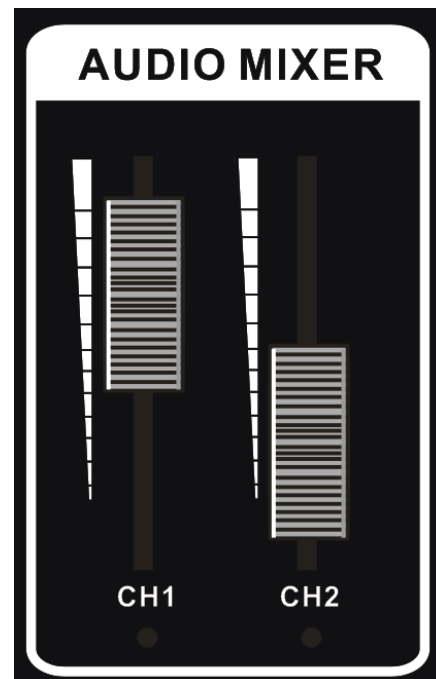

6.1.2.2 Transition Effect Control Area

There are 3 transition modes:

MIX transitions, FADE, and Wipes and INV mirror transition

where the Wipes include: up, down, left, and right.

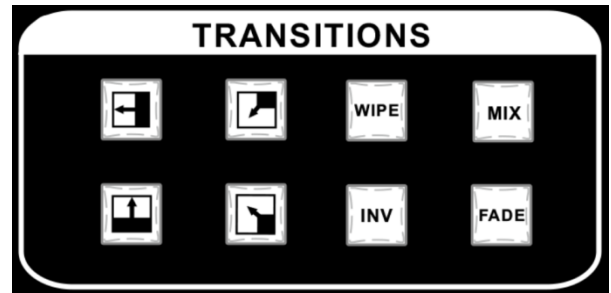



- **MIX Transition**

The MIX effect is a transition effect. After setting the transition, the original live screen will be lightened at the main output and then know that the transition to the new live screen is complete.

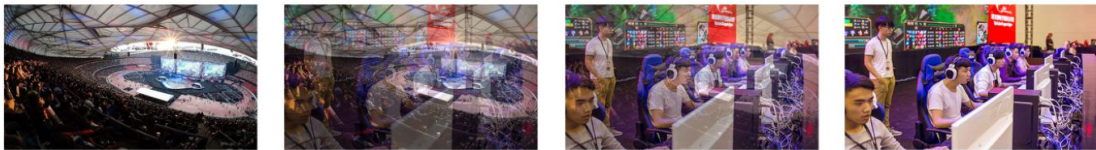

Click on the effect control area (press the green light afterwards), and then click or use the fader or AUTO to switch. The effect is as follows.





A  B
 MIX transition effect, superimposed and superimposed B picture in A picture until the transition to the end, the picture is completely replaced with B picture

- **FADE Transition**

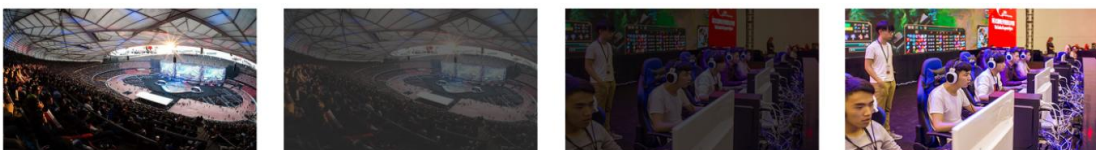

Click on the effect control area (press the green light afterwards), and then click or use the fader or AUTO to switch, under the effect diagram.



A  B
 FADE in and out, and A gradually darkens until it is completely black, and then gradually changes from black to B.

- Four special effects wipe transitions

There are four transition modes for WIPE wipes.



Up transition: Click on the effect control area (press the green light afterwards), and

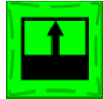

Click on the effect control area (press the green light after pressing).and then click or use the T-bar or AUTO to switch. The effect is as follows. The other three transitions are the same.

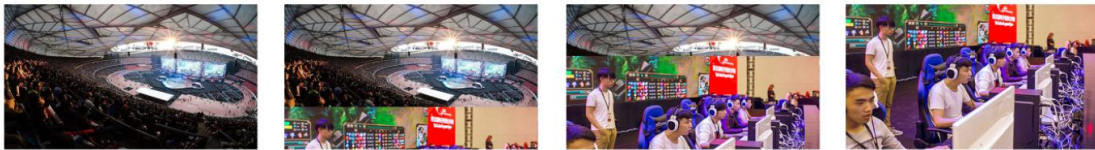

Up transition effect, the A picture is unchanged, and the B picture is gradually drawn in the upward direction until the picture completely becomes B.

- INV mirror effect transition

The INV mirror transition is opposite to the original WIPE transition direction. When the WIPE and INV in the button panel are pressed, and then the direction of the upward transition is pressed,

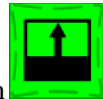

the screen that appears will be the downward transition, and the effect diagram is as follows.

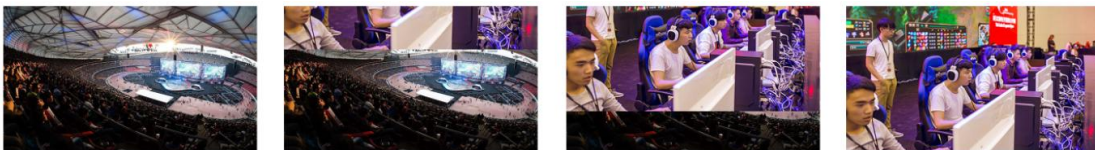

- Transition rate adjustment

When operating the transition effect control area, you can also operate in the button panel. Note: Only when using AUTO transition is effective.

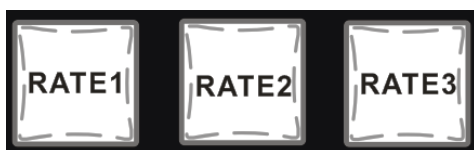

6.1.2.3 Integrated Control Area

- PIP Effect



Picture-in-picture effects: Press the control panel (press the green light afterwards), and then click or use the T-Bar or AUTO to switch. The effect is as follows.

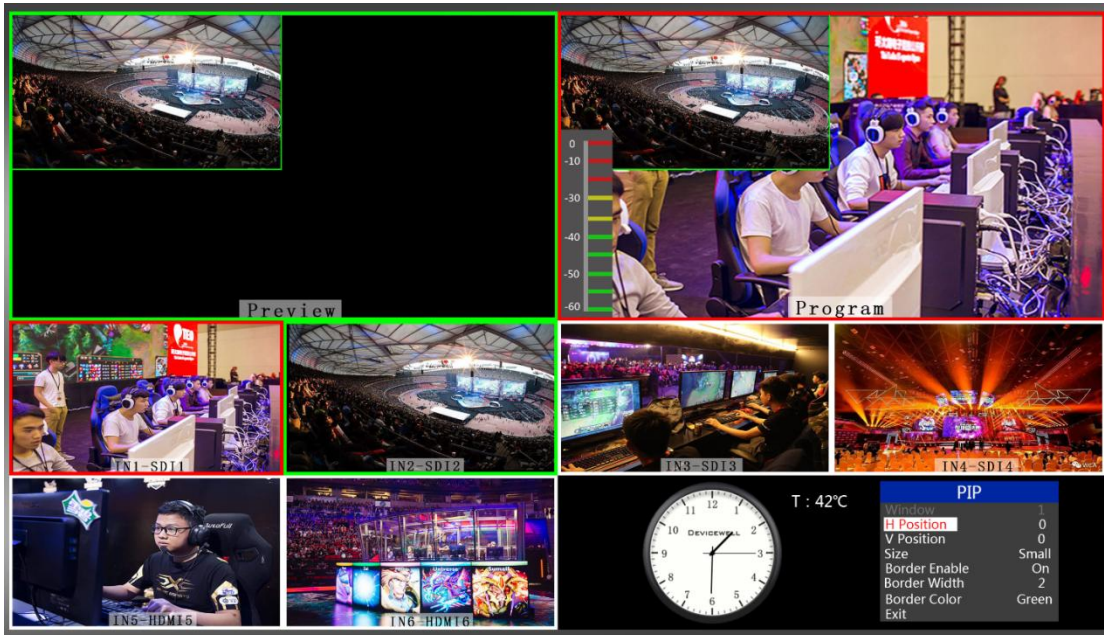

At this time, the information on the LCD screen will be switched to the PIP setting. After pressing the knob, it can be set according to the requirements, as shown below.

PIP	
Window	1
H Position	0
V Position	0
Size	Small
Border Enable	On
Border Width	2
Border Color	Green
Exit	

POP size and position

You can use the knob to set the parameters of the PIP picture-in-picture, as follows (the horizontal/vertical position below is the smallest display image)

Horizontal position setting: The value from the top left to the top right is 0-1440, and the value of one rotation per knob is increased/decreased by 10.

Vertical position setting: The value from the top left to the bottom left is 0-810, and the value of one rotation per knob is increased/decreased by 10.

Display size setting: Small/medium/large settings can be selected.

Border switch setting: You can select the on/off setting.

Border width setting: The border width can be selected from 2-7 thickness borders, and the value of each rotation knob is increased/decreased by 1.

Border color setting: You can choose white/red/green/blue to set the border color.

- POP Effect



Picture-out-Picture effects: Press the control panel (press the green light), then click or use the fader or AUTO to switch. The effect is as follows.

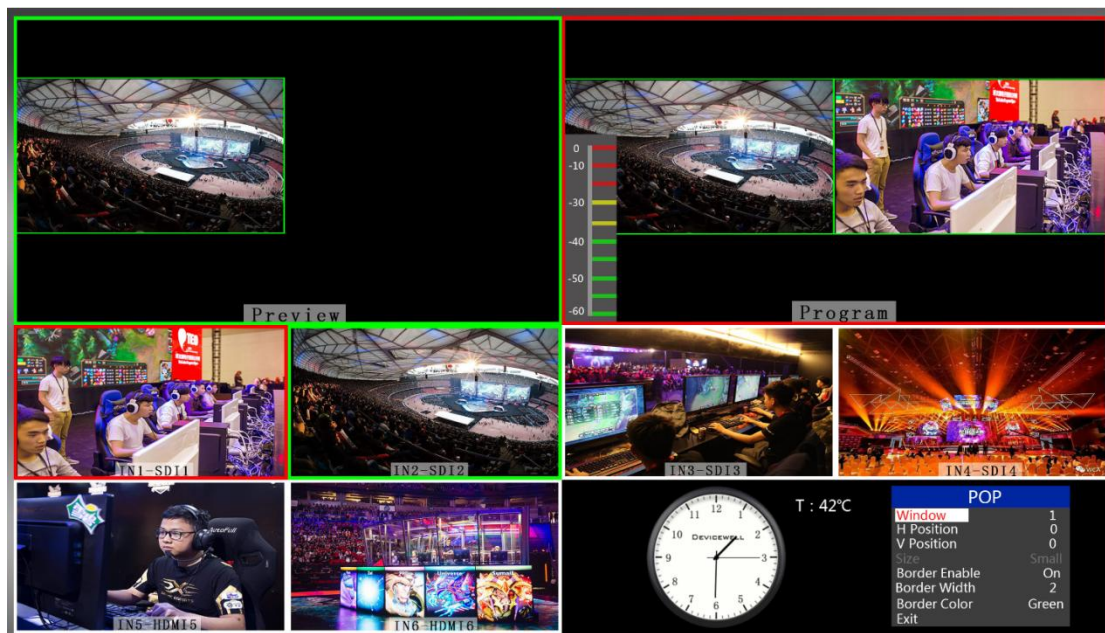

At this time, the information of the multi-screen monitor output will be switched to the POP picture-out-picture setting. After pressing the knob, it can be set according to the requirements, as shown below.

At this time, the information on the LCD screen will be switched to the POP picture drawing setting. After pressing the knob, it can be set according to the requirements, as shown below.

POP	
Window	1
H Position	0
V Position	0
Size	Small
Border Enable	On
Border Width	2
Border Color	Green
Exit	

POP size and position

You can use the knob to set the parameters of the POP, as follows

Screen selection setting: You can select 1/2 two screens.

Horizontal position setting: The value from the top left to the top right is 0-960, and the value of each rotation knob is increased/decreased by 10.

Vertical position setting: The value from the top left to the bottom left is 0-540, and the value of one rotation per knob is increased/decreased by 10.

Border switch setting: You can select the on/off setting.

Border width setting: The border width can be selected from 2-7 thickness borders, and the value of each rotation knob is increased/decreased by 1.

Border color setting: You can choose white/red/green/green to set the border color.

6.1.2.4 PGM & PVW Selection

- Multiview output window introduction



PVW and PGM are the preview and live output respectively, as shown below.

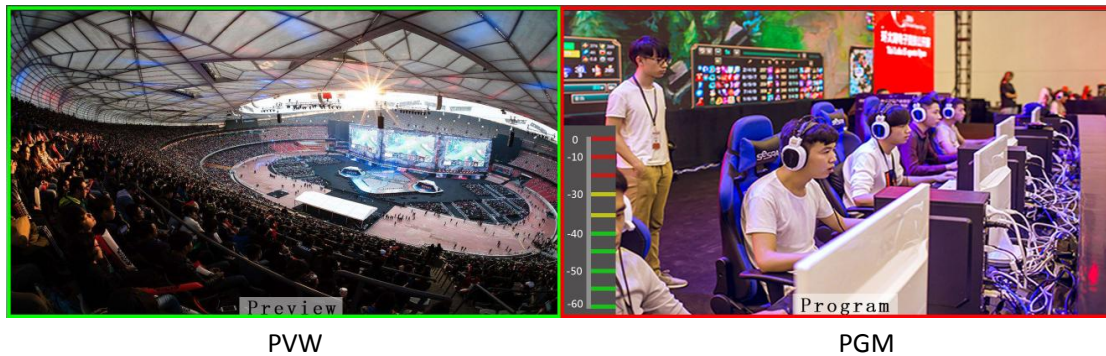

There are 6 windows below which correspond to input source monitoring, corresponding to buttons 1 – 6 on the control panel of the switcher.



- PGM & PVW Output Signal

After the device is connected to the video source, press 1 (PGM) and 2 (PVW) in the button panel. The live and preview signals in the output multi-screen monitor are 1 (PGM) and 2 (PVW) respectively. The signal sources are SDI IN1 and SDI IN2, respectively.

The effect chart is as follows





- PGM & PVW Source Switching

If you want to switch between PGM and PVW source in Multiview

Suppose you want to convert live signal source 1 (PGM) and preview source 2 (PVW) into 2 (PGM) and 1 (PVW) in multiple pictures, just press 2 (PGM) and 1 in the button panel (PVW), then use the T-bar to switch. The live PGM signal source 1-6 can be arbitrarily switched with the preview PVW signal source.

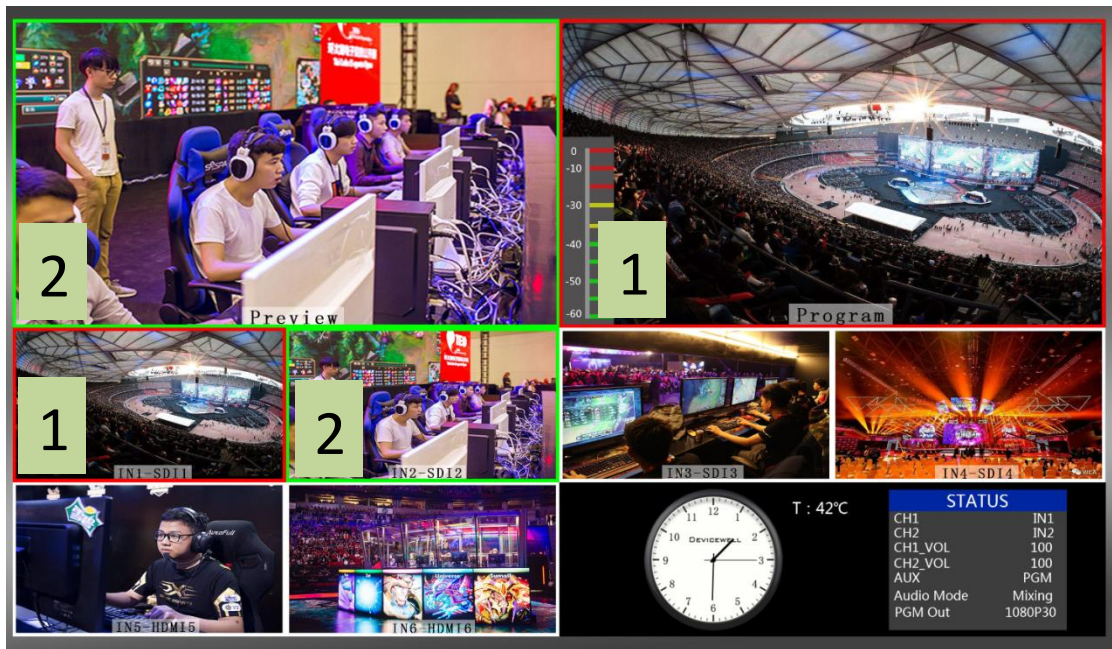
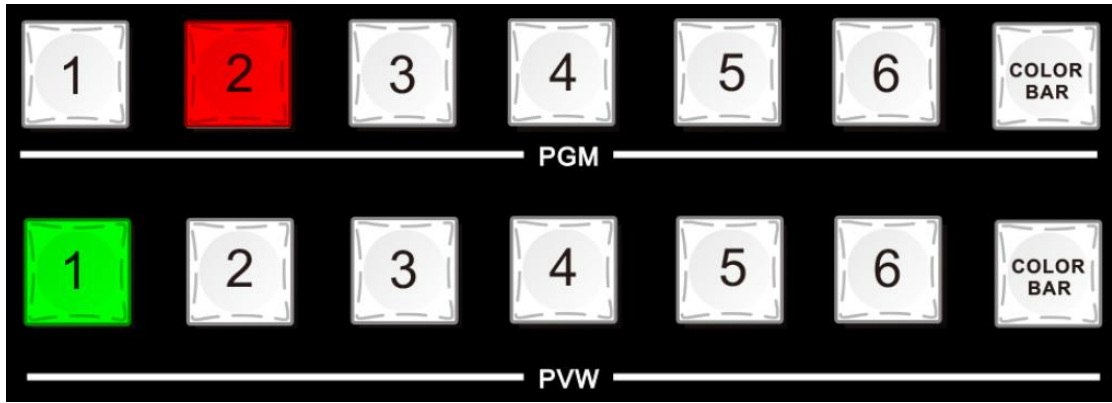
The effect chart is as follows:



The color bar  will be output when the button in the button panel is pressed.

7. System menu settings

- Menu display

In the menu bar, you can perform IP settings on the device, restore the system to factory settings, and change the language.

In the default state of power on, press the knob to enter the main menu, as shown below.

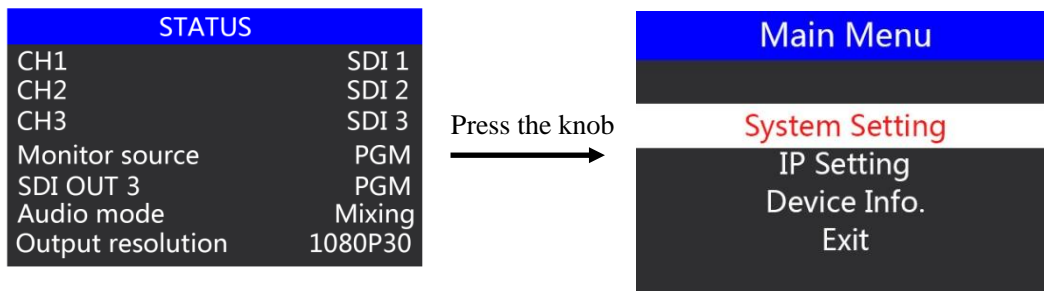

Rotate the knob under the status bar to set the auxiliary output, audio mode, and output resolution;

Auxiliary output: Rotate the knob to customize the PGM / PVW output, corresponding to the AUX output interface on the rear panel;

Audio mode; turn the knob to select mix or follow;

Output resolution: Rotate the knob to operate, you can choose 1080p60 / 1080p50 / 1080p30 / 1080p25 / 1080p24 / 1080i50 / 1080i60

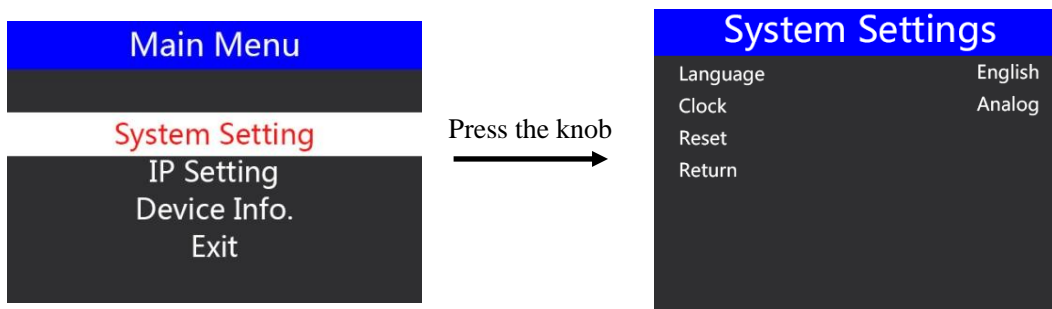

In the system setting menu, you can choose between language selections: Chinese or English. In the time display: select analog or digital display always; if you encounter an unknown error during use, you can choose to restore the factory. Set to reset.

- IP Setting

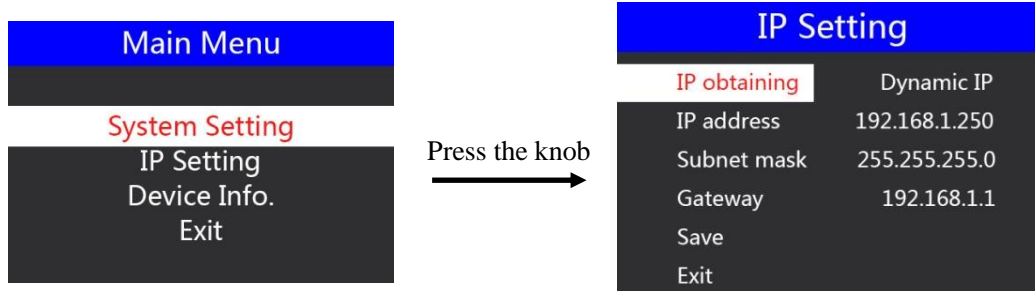

In the network settings menu, you can select in the IP acquisition: dynamic IP or static IP. After selecting the static IP, you can also set the IP address, subnet mask, and network management settings accordingly, and then save and return.

- Device Info.

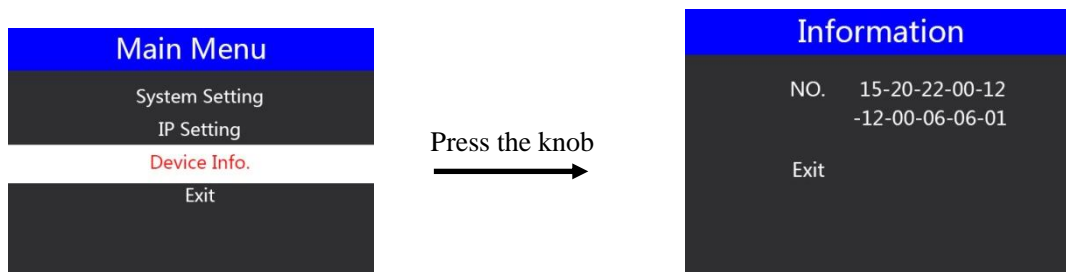

In the device information menu, you can have the serial number information of the device, which cannot be modified here.

8. Failure and Maintenance

8.1 Common Faults and Solutions

(1) The output image may be flickered by interference. The quality of the wire used may be poor, and the shielding layer of the wire is not well prepared. When there is a strong radio near the use environment, radio waves may interfere with the transmission of the signal, resulting in unstable signal flicker. Please use the wire produced by regular manufacturers, such as Belden, Jia Nai Mei.

(2) When plugging in the audio and video interface, if there is obvious static electricity, the

device power ground wire may not be good grounding, please ground in the correct way; otherwise it will easily damage the host and shorten the life of the mainframe.

(3) When RJ45 (generally: Computer network port) cannot control the Switcher, check whether the communication port set by the control software corresponds to the serial port of the connected device; check if the communication port of the computer is good.

8.2 Maintenance

Use a soft, dry cloth to clean the device. Do not use alcohol, paint thinner or benzene to clean. Make sure that the device is stored and operated in an environment away from liquids and stains.

8.2.1 Warranty information

The company guarantees that the process and materials of the product are not defective within 12 months after purchase from the company or its authorized distributors, under normal use and service support. We offer a one-year warranty after sale.